



SFB-Series (Full Brick)

400 W up to 600 W



- ✓ V-Pinout
- ✓ 2:1 /4:1 Wide Range Input
- ✓ Efficiency up to 92%
- ✓ Isolation Input/Output 2250 Vdc
- ✓ Operation Temperature -45 ... +105°C
- ✓ Ceramic Capacitors
- ✓ Long Life-Design
- ✓ No minimum load requirement
- ✓ Output Voltage adjustable $\pm 10\%$
- ✓ Excellent EMI performance
- ✓ Remote On/ Off
- ✓ M3 thread optional for heat sink mounting
- ✓ OVP, OTP, OCP und UVLO
- ✓ Compact Design



The SFB series features isolated, fixed-frequency DC/DC converters utilizing synchronous rectification to achieve high efficiency and excellent EMI performance. Thanks to its enclosed aluminum housing, the module is shielded on all six sides and protected against extreme environmental conditions via vacuum encapsulation.



The standard output voltages of these highly compact converters (see table) are adjustable by $\pm 10\%$. Custom voltages are available upon request.

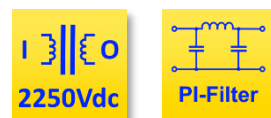

The series features comprehensive protection functions, including SCP, OVP, OCP, and OTP. All protection mechanisms operate in hiccup mode with an automatic restart function.



The modules are available with V-pinout and feature a remote on/off function. The contacts are made of a gold-plated copper alloy to ensure optimal and reproductive soldering results.



The modules comply with the relevant generic standards for railway technology, industry, telecommunications, and defense-tech (see TD).

SFB	110	120	V	P	B	600
Series Name	Input Voltage in Vdc	Output Voltage	Pin out	Remote Control Option	Shape	Power in W
SFB Supreme Full Brick	018: 9...36					
	024: 18...36	120: 12				400
	036: 18...75	240: 24		P: Positive logic	B: Base Plate	up to
	110: 40...180	280: 28	V: Vicor	N: Negative logic		600
	300: 180...425	480: 48				



**Custom Design
Communication**



Model Selection Guide

Typical @ Ta=+25 °C under nominal line voltage conditions unless noted

Model	Input			Output			Efficiency
	Voltage (V)		Current (A)	Voltage	Current	Power	
	Range	Nominal	Full load	(V)	(A)	(W)	Typ. (%)
SFB018120-V-□-B400	9-36	18	25.25	12	33.33	400	88
SFB018240-V-□-B400	9-36	18	25.25	24	16.67	400	88
SFB018280-V-□-B400	9-36	18	25.25	28	14.28	400	88
SFB018480-V-□-B400	9-36	18	25.25	48	8.33	400	88
SFB024120-V-□-B600	18-36	24	28.09	12	50	600	89
SFB024240-V-□-B600	18-36	24	28.09	24	25	600	89
SFB024280-V-□-B600	18-36	24	28.09	28	21.42	600	89
SFB024480-V-□-B600	18-36	24	28.09	48	12.5	600	89
SFB036120-V-□-B600	18-75	36	18.94	12	50	600	88
SFB036240-V-□-B600	18-75	36	18.94	24	25	600	88
SFB036280-V-□-B600	18-75	36	18.94	28	21.42	600	88
SFB036480-V-□-B600	18-75	36	18.94	48	12.5	600	88
SFB110120-V-□-B600	40-180	110	6.20	12	50	600	88
SFB110240-V-□-B600	40-180	110	6.20	24	25	600	88
SFB110280-V-□-B600	40-180	110	6.20	28	21.42	600	88
SFB110480-V-□-B600	40-180	110	6.20	48	12.5	600	88
SFB300120-V-□-B600	180-425	300	2.22	12	50	600	90
SFB300240-V-□-B600	180-425	300	2.20	24	25	600	91
SFB300280-V-□-B600	180-425	300	2.20	28	21.42	600	91
SFB300480-V-□-B600	180-425	300	2.25	48	12.5	600	89

Block diagram:

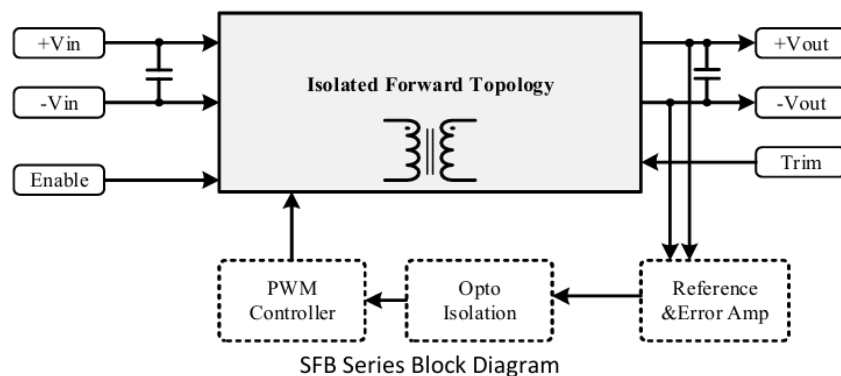



Input Specifications (Typical @ Ta= +25°C under nominal line voltage conditions unless noted.)

Parameter	Notes and Conditions	Min.	Typ.	Max.	Unit
Transient Input Voltage Ranges	SFB018 models (100ms Max)			50	VDC
	SFB024 models (100ms Max)			50	
	SFB036 models (100ms Max)			100	
	SFB110 models (100ms Max)			250	
	SFB300 models (100ms Max)			500	
Operating Input Voltage Ranges	SFB018 models	9	18	36	VDC
	SFB024 models	18	24	36	
	SFB036 models	18	36	75	
	SFB110 models	40	110	180	
	SFB300 models	180	300	425	
Over-Voltage Turn-off Voltage	SFB018 models			48	VDC
	SFB024 models			48	
	SFB036 models			85	
	SFB110 models			195	
	SFB300 models			470	
Over-Voltage Turn-on Voltage	SFB018 models	36			VDC
	SFB024 models	36			
	SFB036 models	75			
	SFB110 models	180			
	SFB300 models	425			
Under-Voltage Lockout Turn-on Voltage	SFB018 models			9	VDC
	SFB024 models			18	
	SFB036 models			18	
	SFB110 models			40	
	SFB300 models			180	
Under-Voltage Lockout Turn-off Voltage	SFB018 models		8		VDC
	SFB024 models		17		
	SFB036 models		17		
	SFB110 models		38		
	SFB300 models		175		
Input Current	See model selection guide, Standby mode (OFF, UVLO) 5mA				
Enable Function Input	Positive logic	ON	Open		VDC
		OFF	Short or 0 ~ 1.2		
	Negative logic	ON	Short or 0 ~ 1.2		VDC
		OFF	Open		

Output Specifications

Parameter	Notes and Conditions	Min.	Typ.	Max.	Unit
Output Voltage Accuracy	V _{NOM} 50% Load			±1.5	%
Line Regulation	Low Line to High Line			±0.3	%
Load Regulation	10% to 100% Load			±0.5	%
Output Ripple & Noise Voltage	Bandwidth 20MHz and with 1µF MLCC Output Capacitor		1.5		%V _{pk-pk}
Temperature Coefficient				±0.04	% /°C
Transient Recovery Time	25% load step change		800		µSec.
Transient Peak Deviation	ΔI _o /Δt=2.5A/us		±2		%V _o
Start-Up Time	When use Enable Function		20		mSec.
Trimming Output Voltage	V _{NOM} 10% Load		±10		%
Over Voltage Protection	V _{NOM} 10% Load		120		%
Output Power Protection	V _{NOM}		120		%



General Specifications & Environmental Specifications

Parameter	Notes and Conditions	Min.	Typ.	Max.	Unit
Switching Frequency	V _{NOM}		250		kHz
Storage Temperature Range	All models	-60		125	°C
Operating Case Temperature	All models	-45		105	°C
Over temperature Protection	All models, Auto. Recovery		110		
Isolation Voltage Input to Output	All models, 1 Minute	2250			VDC
Isolation Resistance Input to Output	All models, 500VDC, At 70%RH	100			MΩ
Isolation Capacitance Input to Output	All models		1500		pF
Humidity (non condensing)	All models			95	%
Calculated MTBF	BellCore-TR-332@ 50°C G.B		TBD		M HR
Thermal shock	Environmental Engineering Experimental Tests	MIL-STD-810F			
Vibration		MIL-STD-810F			
Drop		MIL-STD-810F			
Weight	Shape-B	225			g (oz.)
Dimensions	Shape-B	4.62" x 2.40" x 0.59" (117.3 x 61.0 x 15.0mm)			
Case Material	Aluminum				
Potting Material	Silicone				

Standards Compliance

Parameter	Standard	Test Conditions	Performance Criteria
Environmental Compliance	Reach; RoHS		PASS
EMI	EN55022		Class A / Class B
ESD	EN61000-4-2	±4 kV Air Discharge ±4 kV Contact Discharge	Crit. A
Radiated Immunity	EN61000-4-3	Level 2, 3 V/m	Crit. A
Fast Transient	EN61000-4-4	±2 kV Applied	Crit. A
Surge	EN61000-4-5	±2 kV Applied	Crit. A
Conducted Immunity	EN61000-4-6	Level 2, 3 V rms	Crit. A

It is recommended to protect the input by fuses or other protection devices.

Modules could meet EN55022 Class A and Class B standard with external components.

The information and specifications contained in this data sheet are believed to be correct at time of publication. All specifications are subject to change without notice. No rights under any patent accompany the sale of any such products or information contained herein.



Mechanical Dimensions & Pin Assignment

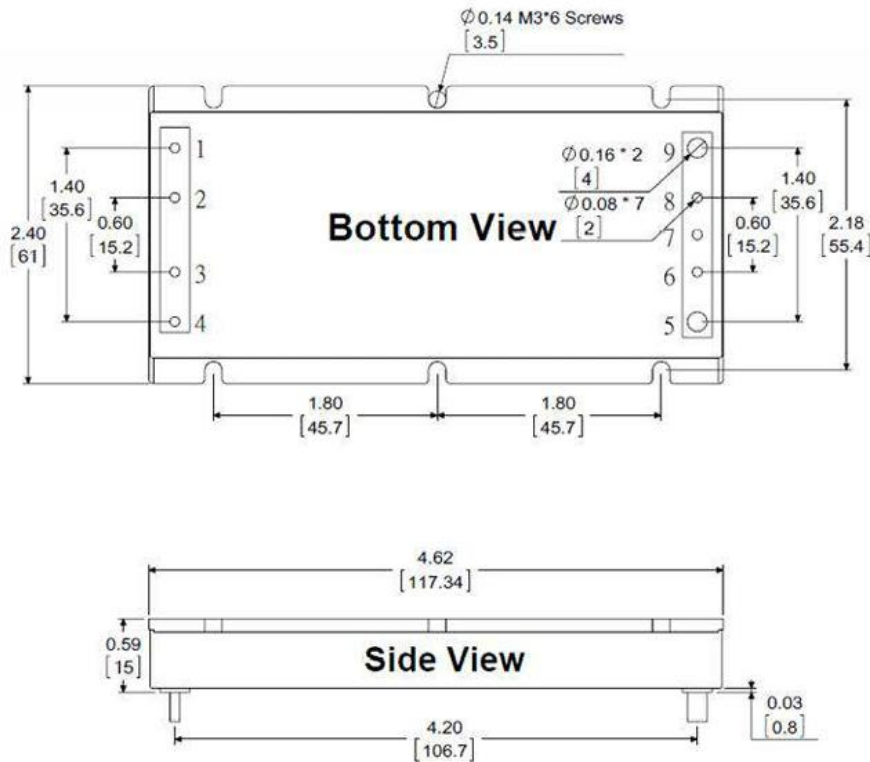

Pin#	Function
1	-Vin
2	--
3	Enable
4	+Vin
5	+Vout
6	+Sense
7	Trim
8	-Sense
9	-Vout

Note:

- Pin Material: Copper Alloy
- Pin Plating: Gold
- Dimensions: in inches [mm]
- Tolerances: .XX±0.02 [.X±0.5mm]

Testing conditions are at typical input, Ta=+25°C, full load (horizontal mount) Unless otherwise indicated

The figures of SFB300480-V-P-B600

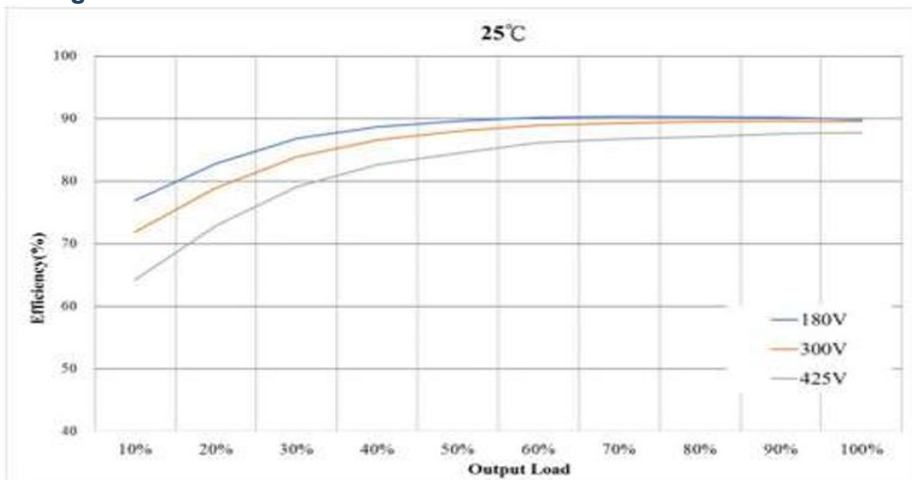

Figure 1 : Efficiency at Minimum, Nominal and Maximum Input Voltages VS. Output Load.

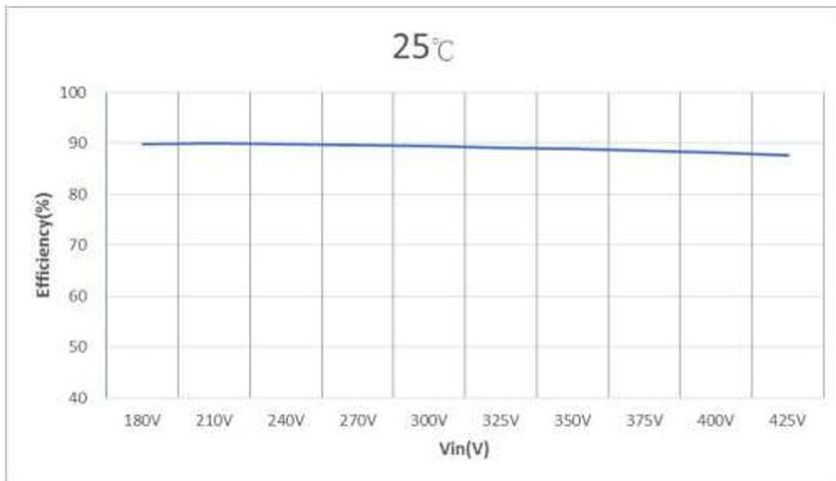

Figure 2 : Efficiency VS. Input Voltages at 100% rated power

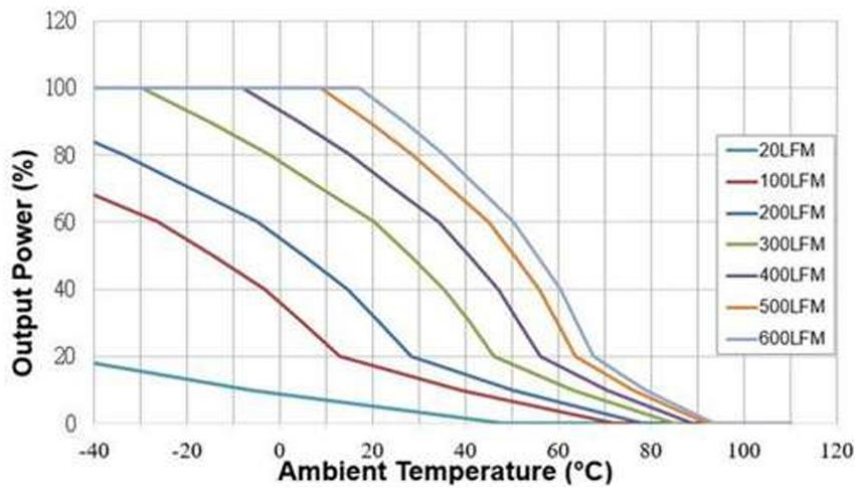

Figure 3 : Ambient Temperature VS. Output Power Derating Curves (Note: 20LFM = Free Air)

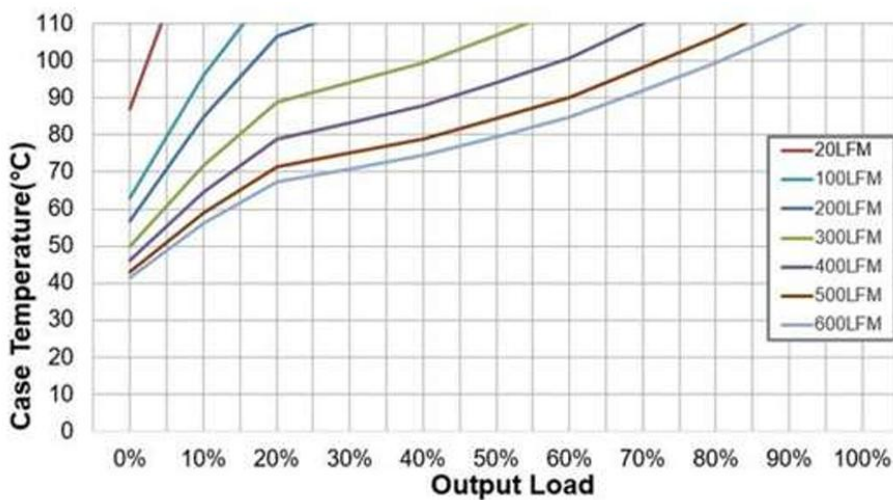

Figure 4 : Case Temperature VS. Output rated Power (Note: 20LFM = Free Air)

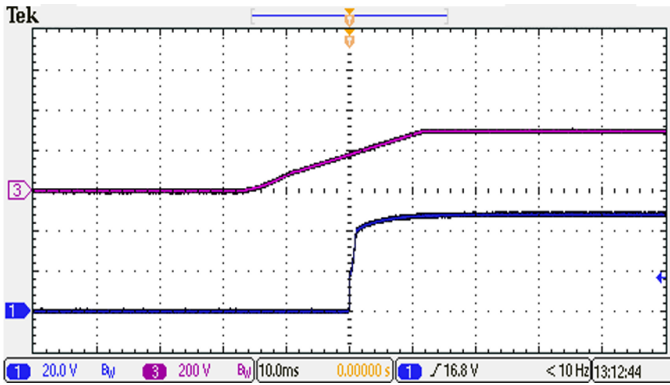

Figure 5 : CH1 = Vout, CH3 = Nominal Input typical Start-up waveform at Full load.

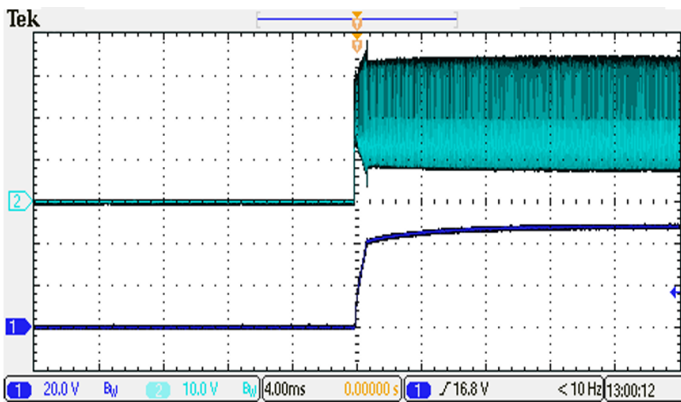

Figure 6 : CH1 = Vout, CH2 = Enable Pin typical Start-up waveform. Input voltage pre-applied

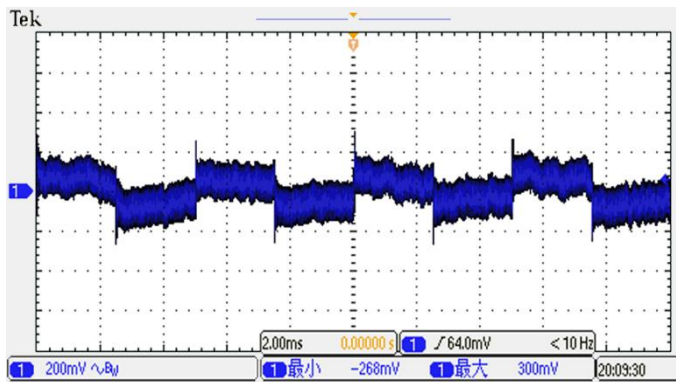

Figure 7 : Transient Response at Output step load (V_{in} : Typical, 25~50% of output current; $\Delta I_o/\Delta t = 1A/\mu S$)

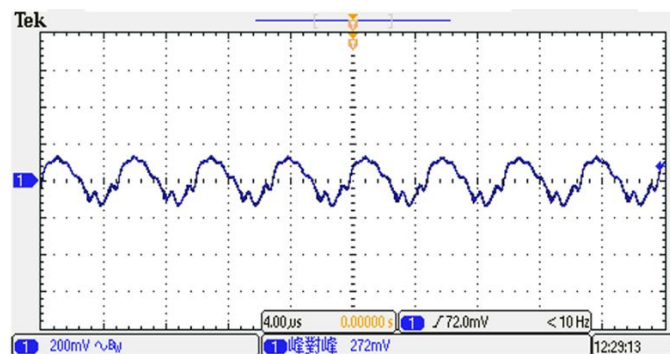

Figure 8 : Output Voltage Ripple & Noise at full load. (V_{in} : Typical, With Output Capacitor to add 1μF MLCC)



Trimming Output Voltage – for Single output models

Only the single output converters have a trim function. That allows users to adjust the output voltage from +10% to –10%, please refer to the trim table that follow for details.

Adjustments to the output voltage can be used with a simple fixed resistor as shown in Figures 1 and 2. A single fixed resistor can increase or decrease the output voltage depending on its connection.

Note:

Trim adjustments higher than the specified range can have an adverse effect on the converter’s performance and are not recommended.

If the trim function is not used, leave the trim pin open.

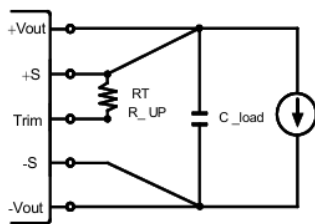

Figure 1. Trim Connections To increase Output Voltages Using Fixed Resistors

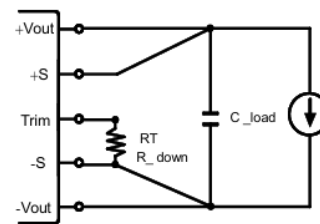

Figure 2. Trim Connections To Decrease Output Voltages Using Fixed Resistors

Vout	Trim up resistor value(KΩ)									
	1%	2%	3%	4%	5%	6%	7%	8%	9%	10%
12	258	115	67	44	29	20	13	7.8	3.8	0.6
24	514	232	137	90	62	43	30	20	12	5.5
28	602	271	161	105	72	50	34	22	13	5.9
48	1039	464	273	177	120	81	54	34	18	5

Vout	Trim down resistor value(KΩ)									
	-1%	-2%	-3%	-4%	-5%	-6%	-7%	-8%	-9%	-10%
12	358	162	96	63	44	31	21	14	8.9	4.5
24	769	352	213	143	102	74	54	39	28	18
28	860	392	236	158	111	80	57	41	28	17
48	1413	638	380	251	173	121	85	57	35	18

Enable Control Function

The primary-side, Enable Control function can be specified to operate with either positive or negative polarity. Positive-polarity devices are enabled when the enable pin is left open or is pulled high. See “Enable Function Input.

Positive-polarity devices are disabled when the enable pin is pulled low (under +1.0V with respect to –input). Negative-polarity devices are off when the enable pin is high/open and on when the enable pin is pulled low. See Figure 3.

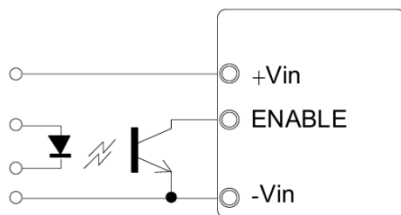

Figure 3. Driving the Enable Control pin

Output Ripple Noise

The two copper strips simulate real-world PCB impedances between the converter and its load. Scope measurements should be made using BNC connectors or the probe ground should be less than 1/2 inch and soldered directly to the fixture.

All external capacitors should have appropriate voltage ratings and be located as close to the converter as possible.

Temperature variations for all relevant parameters should be taken into consideration. The most effective combination of external I/O capacitors will be a function of line voltage and source impedance, as well as particular load and layout conditions. See Figure 4.

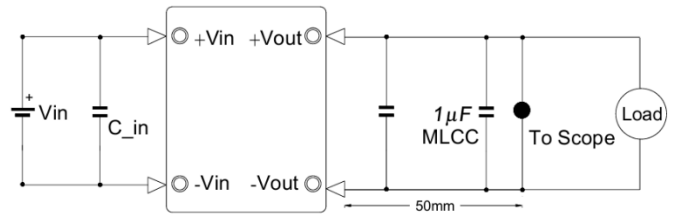

Figure 4. Measuring Output Ripple/Noise(20MHz bandwidth)



Power Electronics at a Glance:

AC/DC Power Supplies
3W...750W



AC/DC High Performance PSUs
1kW...3,5kW

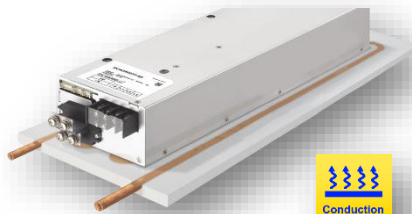

AC/DC Powermodules
2W...150W



DC/DC High Power Modules
V-Pin compatible & DOSA
10W ... 600W



DC/DC Converter 60W...2kW
galvanically isolated



DC/AC Inverter 260W...6kW
1ph. 230Vac/ 3ph. 400Vac



AC/DC High Power Modules
100W...700W



External Adaptors
4,5W ... 550W



DC/DC Printmodules
2W ... 400W



BLUM Germany GmbH
Hohenraunauerstr. 9
D-86480 Aletshausen

Let's talk!