

## Basic Characteristics Data

Model	Circuit method	PCB/Pattern		
		Material	Single sided	Double sided
KRE-20A	Diode	FR-4		Yes
KRE-40A	Diode	FR-4		Yes

<b>1</b>	<b>Terminal Blocks</b>	<b>KR-6</b>
<b>2</b>	<b>Functions</b>	<b>KR-6</b>
2.1	Input Voltage Range .....	KR-6
2.2	Isolation .....	KR-6
2.3	Signal Output .....	KR-6
<b>3</b>	<b>Peak Current</b>	<b>KR-6</b>
<b>4</b>	<b>Assembling and Installation Method</b>	<b>KR-7</b>
4.1	Installation Mounting methods .....	KR-7
4.2	Derating curve depend on ambient temperature .....	KR-7
4.3	Applicable Electric Cable .....	KR-8
4.4	Others .....	KR-8

# 1 Terminal Blocks

● KRE-20A/-40A

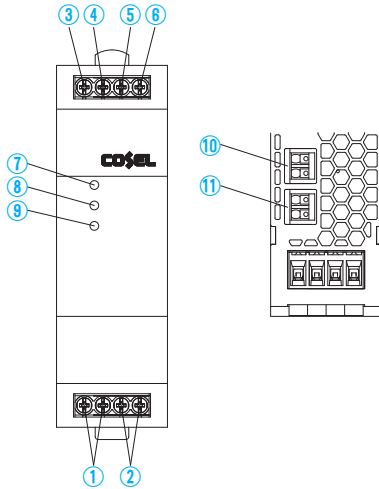

Terminal Number	Terminal Name	Function
①	+VOUT	+Output Terminals
②	-VOUT	-Output Terminals
③	+VIN1	+Input Terminals 1
④	-VIN1	-Input Terminals 1
⑤	+VIN2	+Input Terminals 2
⑥	-VIN2	-Input Terminals 2
⑦	DC_OK1	LED for input voltage 1 confirmation
⑧	DC_OK2	LED for input voltage 2 confirmation
⑨	Balance_OK	LED for input voltage balance confirmation
⑩	DC_OK1	Input voltage 1 confirmation (relay contact)
⑪	DC_OK2	Input voltage 2 confirmation (relay contact)

# 2 Functions

## 2.1 Input Voltage Range

■ Input voltage range of the module is from DC10V to DC60V(KRE-20A), DC10V to 30V(KRE-40A).

To comply with safety standards, input voltage range is  
 KRE-20A: [DC10V to DC60V]  
 KRE-40A: [DC10V to DC30V]

■ If input value doesn't fall within above range, a unit may not operate in accordance with specifications or fail.

## 2.2 Isolation

- When you run a Hi-Pot test as receiving inspection, gradually increase the voltage to start. When you shut down, decrease the voltage gradually by using a dial. Please avoid a Hi-Pot tester with a timer because, when the timer is turned ON or OFF, it may generate a voltage a few times higher than the applied voltage.
- When you test a unit for isolation between the input-output and the DC\_OK, or between the DC\_OK and the chassis, short all terminals of DC\_OK.

## 2.3 Signal Output

■ LED indicators and signal output in the form of relay contact are signals to check the presence/absence of voltage at the input terminal of a unit.

The timing of signals might be vary depending on input and load conditions. Please make sure enough evaluation.

Table 2.1 Description of the signal output

Signal Output	More than 10V	※1
DC_OK1 (LED: Green)	ON	OFF
DC_OK2 (LED: Green)	ON	OFF
DC_OK1 (Relay Output) ※2	Short	Open
DC_OK2 (Relay Output) ※2	Short	Open

Caution on signal outputs :

■ The timing of signals might be very depending on models, input and load conditions.

※1 In case of that the input terminal voltage is less than 8V or less than approximately 50% of another the input terminal voltage, LED turns off and DC\_OK relay opens.

※2 This circuit is insulated from other circuits (input and output).

■ It is possible to check the input voltage difference by using Balance\_OK LED indicator in order to make a voltage balance of connected two power supplies.

In case that the input voltage difference is small, LED lights up and the output current of the connected two power supplies tends to be balanced. It expects longer life time than unbalanced condition.

In case that the input voltage difference is not small enough, LED is turned off.

The timing of LED indicator might be vary depending on input and load conditions. Please make sure enough evaluation.

※ Same input cables (length and diameter) from the two power supplies are recommended in order to make a better balance.

# 3 Peak Current

■ The units can generate the peak current under the following conditions.

- $t1 \leq 5\text{sec}$
- $I_p \leq \text{Rated peak current}$
- $I_{ave} \leq \text{Rated current}$
- $\text{Duty} \leq 35\%$
- $\text{Duty} = \frac{t1}{t1+t2} \times 100 [\%]$

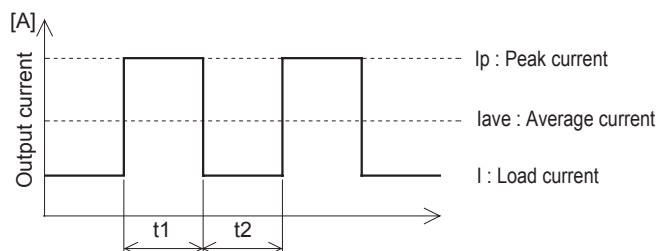

Fig.3.1 Peak current

# 4 Assembling and Installation Method

## 4.1 Installation Mounting methods

- About DIN-Rail  
Attachment available with DIN EN60715 TH 35 (35×7.5mm or 35×15mm) (Top hat shaped DIN rail)
- Below shows mounting orientation.  
If install other than standard mounting orientation (A), please fix the power supply for withstand the impact and vibration.

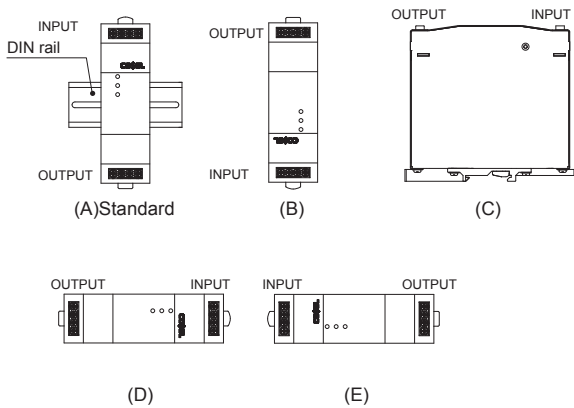

Fig.4.1 Mounting orientation

- When you mount a power supply on a DIN rail, have the area marked A catch one side of the rail and push the unit to the direction of B. To remove the power supply from the rail, either push down the area marked C or insert a tool such as driver to the area marked D and pull the unit apart from the rail. When you couldn't remove the unit easily, push down the area marked C while lightly pushing the unit to the direction of E.

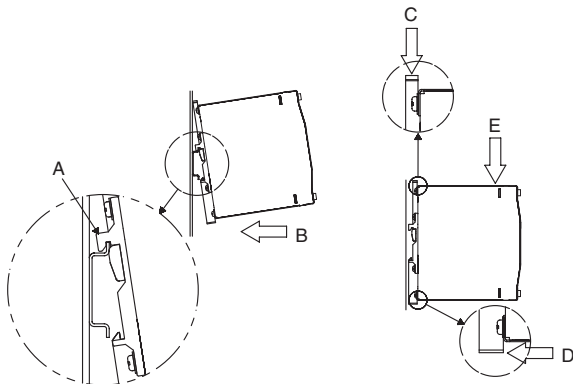

Fig.4.2 Installation method

- Shown below the notes about installation clearance of a unit.
- ① Installation clearance at above and below the unit.  
Please have clearance of at least 25mm above and below the unit to avoid heat accumulation.

- ② Installation clearance at the side of the unit.  
Please have clearance of at least 15mm side the unit to avoid interfering with heat radiation from housing.

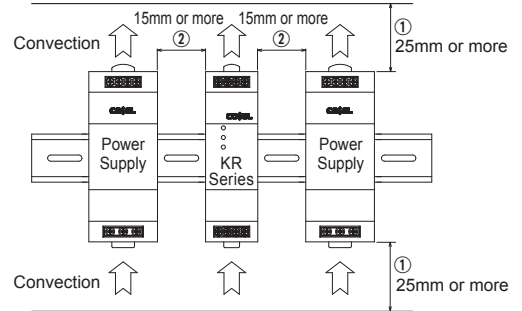

Fig.4.3 Installation clearance

## 4.2 Derating curve depend on ambient temperature

- The operative ambient temperature as different by input voltage.  
Derating curve is shown below.
- Derating Curve (Convection)

### ●KRE-20A

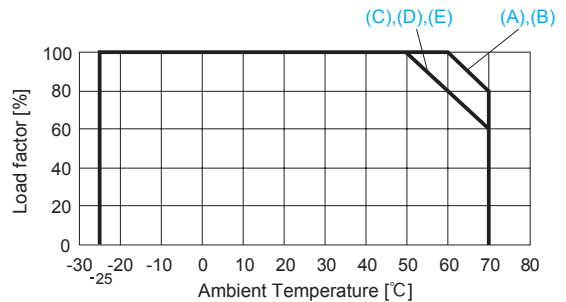

Fig.4.4 Derating curve depend on ambient temperature

### ●KRE-40A

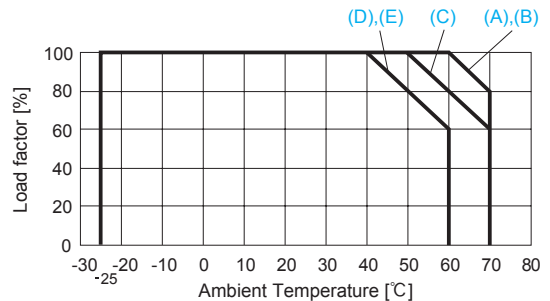

Fig.4.5 Derating curve depend on ambient temperature

- ※ In KRE-40A, if you use the AWG12 wire, please use at 10deg lower than the derating curve shown on Fig.4.5, since the heat generation of the wire increases.

■ Ambient temperature indicates the temperature of the inlet of the air.

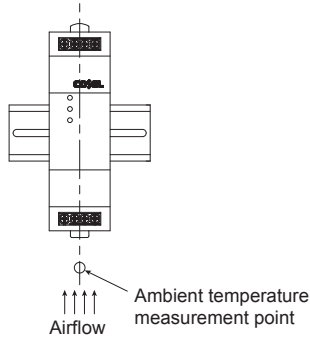

Fig.4.6 Ambient temperature measurement point

■ Temperature of Forced air

※ UL508 (Listing) is excluded.

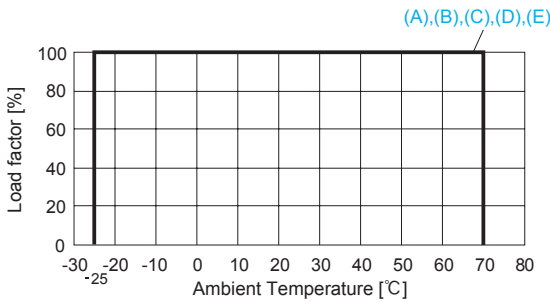

Fig.4.7 Derating curve depend on ambient temperature

■ Temperature of Forced air

Use the temperature measurement point as shown in Fig 4.8.  
Please use at the temperature does not exceed 75°C.  
Please also make sure that the ambient temperature does not exceed 70°C.

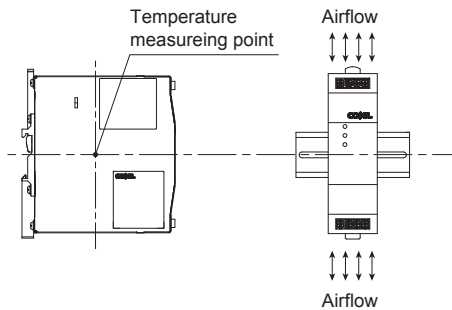

Fig.4.8 Temperature measurement point (Forced air)

### 4.3 Applicable Electric Cable

■ Input terminals, Output terminals

● KRE-20A, KRE-40A

Table 4.1 Applicable Wire

	Input terminals	Output terminals
Solid wire	Diameter 2.0 mm to 2.6 mm (AWG.12 to AWG.10)	
Stranded wire	3.3mm <sup>2</sup> to 5.2mm <sup>2</sup> (AWG.12 to AWG.10) Conductor diameter more than 0.18mm	
Sheath strip length	8mm	

※ For safety standard certification, please use wires of the following rated temperature.

UL508 : 75°C min

C-UL (CSA) : 105°C min

■ DC\_OK terminals

Table 4.2 Applicable Wire

	DC_OK terminals
Solid wire	Diameter 0.5 mm to 1.3 mm (AWG.24 to AWG.16)
Stranded wire	0.2mm <sup>2</sup> to 1.5mm <sup>2</sup> (AWG.24 to AWG.16)
Sheath strip length	8mm

### 4.4 Others

■ While turning on the electricity, and for a while after turning off, please don't touch the inside of a power supply because there are some hot parts in that.

■ Please avoid applying a voltage exceeding the rated voltage to an output terminal. Doing so may cause a power supply to malfunction or fail. If you cannot avoid doing so, for example, if you need to operate a motor, etc., please install an external diode on the output terminal to protect the unit.